



TECHNOLOGY
SOLUTIONS UK LTD

USER GUIDE: 1166 *BLUETOOTH*[®] UHF RFID READER



www.tsl.com

Design • Development • Manufacture

TERMS & CONDITIONS

Copyright © 2019 Technology Solutions (UK) Ltd. All rights reserved.

No part of this publication may be reproduced or used in any form, or by any electrical or mechanical means, without permission in writing from Technology Solutions (UK) Ltd. This includes electronic or mechanical means, such as photocopying, recording, or information storage and retrieval systems. The material in this manual is subject to change without notice.

Technology Solutions (UK) Ltd (TSL®) reserves the right to make changes to any product to improve reliability, function, or design. TSL® does not assume any product liability arising out of, or in connection with, the application or use of any product, circuit, or application described herein. No license is granted, either expressly or by implication, estoppel, or otherwise under any patent right or patent, covering or relating to any combination, system, apparatus, machine, material, method, or process in which TSL® products might be used. An implied license exists only for equipment, circuits, and subsystems contained in TSL® products. TSL® and the TSL® logo are registered trademarks of TSL®. Other product names mentioned in this manual may be trademarks or registered trademarks of their respective companies and are hereby acknowledged.

All software is provided strictly on an “as is” basis. All software, including firmware, furnished to the user is on a licensed basis. TSL® grants to the user a non-transferable and non-exclusive license to use each software or firmware program delivered hereunder (licensed program). Except as noted below, such license may not be assigned, sublicensed, or otherwise transferred by the user without prior written consent of TSL®. No right to copy a licensed program in whole or in part is granted, except as permitted under copyright law. The user shall not modify, merge, or incorporate any form or portion of a licensed program with other program material, create a derivative work from a licensed program, or use a licensed program in a network without written permission from TSL®. The user agrees to maintain TSL’s copyright notice on the licensed programs delivered hereunder, and to include the same on any authorized copies it makes, in whole or in part. The user agrees not to decompile, disassemble, decode, or reverse engineer any licensed program delivered to the user or any portion thereof. TSL® reserves the right to make changes to any software or product to improve reliability, function, or design. TSL® does not assume any product liability arising out of, or in connection with, the application or use of any product, circuit, or application described herein.

iPad, iPad Air, iPad mini, iPad Pro, iPhone, iPod, iPod touch are trademarks of Apple Inc., registered in the U.S. and other countries. IOS is a trademark or registered trademark of Cisco in the U.S. and other countries and is used under license.

Use of the Made for Apple badge means that an accessory has been designed to connect specifically to the Apple product(s) identified in the badge and has been certified by the developer to meet Apple performance standards. Apple is not responsible for the operation of this device or its compliance with safety and regulatory standards.

The *Bluetooth*® word mark and logos are registered trademarks owned by Bluetooth SIG, Inc. and any use of such marks by Technology Solutions (UK) Ltd is under license. Other trademarks and trade names are those of their respective owners.

CONTENT

Introduction.....	4
Parts of the 1166 UHF Reader.....	4
Using the 1166 UHF Reader.....	5
Removing/Installing the Battery.....	5
Charging and USB Connection.....	8
Button Operation.....	9
Reading Transponders.....	10
Status LEDs.....	11
Connections.....	12
<i>Bluetooth</i> [®] wireless technology connection.....	12
Comparison of <i>Bluetooth</i> [®] Operating Modes.....	13
Changing the <i>Bluetooth</i> [®] Operating Mode.....	14
Setting up a <i>Bluetooth</i> [®] Connection with an Apple Product.....	16
Embedded SD Card.....	21
Summary.....	21
Auto Run File (AUTO.TXT).....	21
Log File (LOG.TXT).....	21
Software Development.....	23
Troubleshooting and Maintenance.....	24
Maintenance.....	24
Troubleshooting.....	24
Regulatory information.....	25
Information to the user – FCC.....	25
RF Exposure Guidelines.....	25
Canadian Warning Statements.....	25
Laser Warning.....	27
Health and Safety Recommendations.....	28
Waste Electrical and Electronic Equipment (WEEE).....	29
Warranty.....	29
About TSL [®]	31
About.....	31
Contact.....	31

INTRODUCTION

Technology Solutions' 1166 UHF Reader provides Ultra High Frequency (UHF) Radio Frequency Identification (RFID), with optional barcode scanning functionality. The unit can be used stand alone or paired with a *Bluetooth*® wireless technology enabled host device. It can be used with UHF transponders including the EPC Global Class 1 Generation 2 transponders.

PARTS OF THE 1166 UHF READER

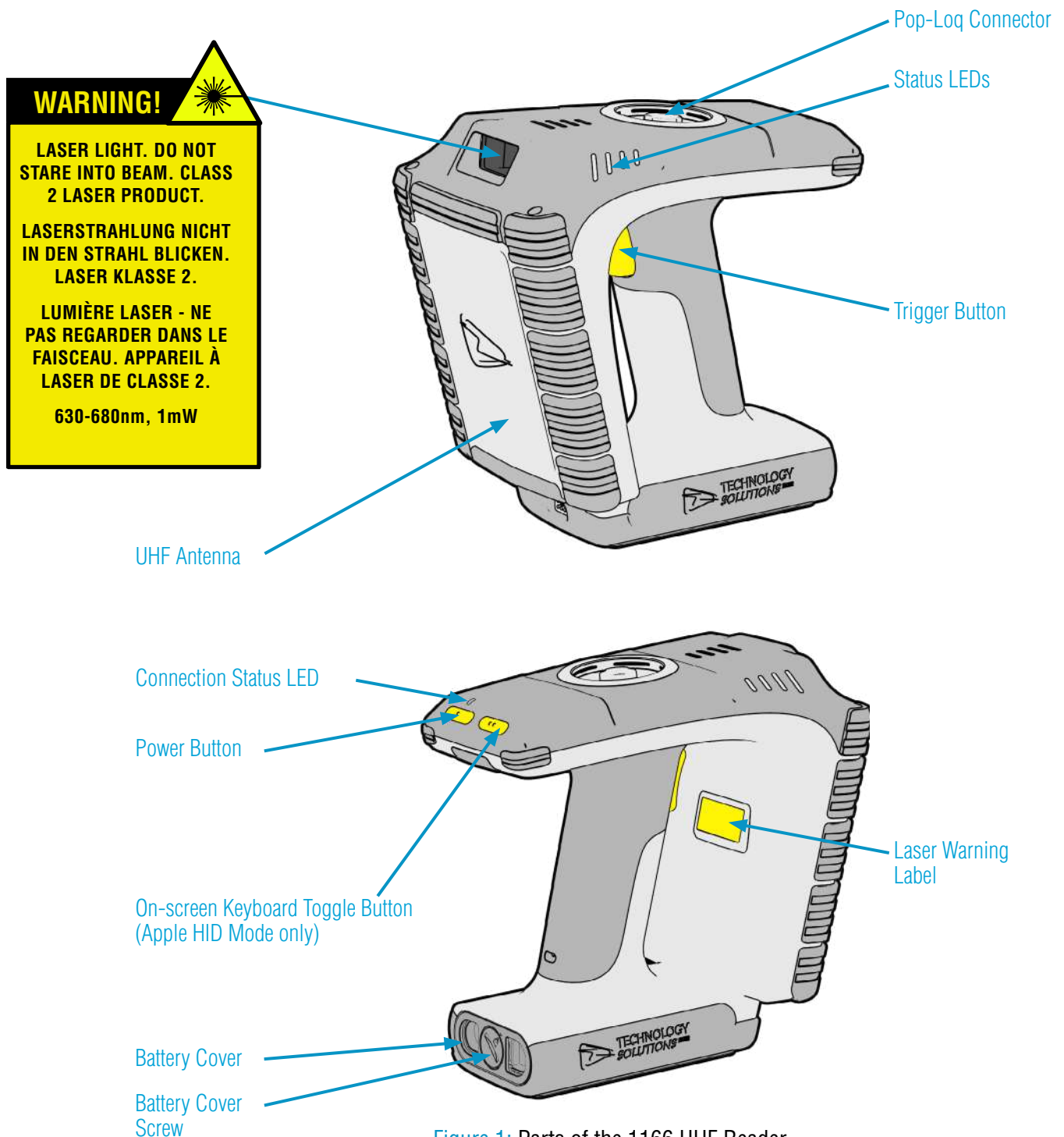

Figure 1: Parts of the 1166 UHF Reader

USING THE 1166 UHF READER

REMOVING/INSTALLING THE BATTERY

REMOVING THE BATTERY

To remove the battery, locate the screw on the Battery Cover and rotate it anti-clockwise using a mid-sized coin. The Battery Cover can then be removed. The battery and 'Battery Pull Tab' will now be visible. Use the 'Battery Pull Tab' to slide the battery out.

- 1 Locate 'Battery Cover Screw'

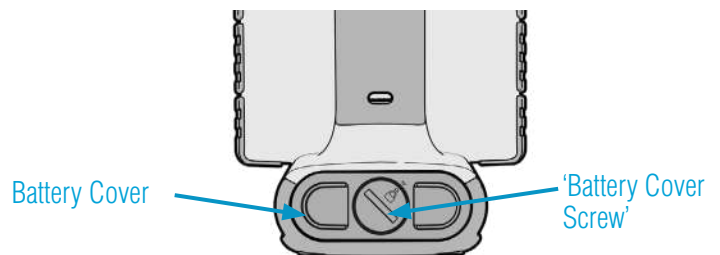
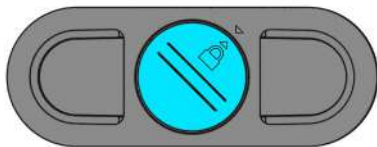

- 2 Rotate 'Battery Cover Screw' anti-clockwise by about two thirds of a turn.

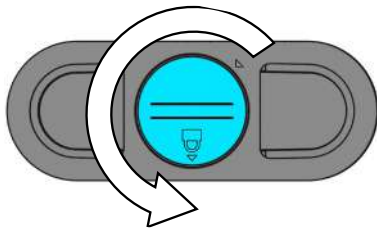

- 3 Remove the 'Battery Cover' using the finger holes and then pull on the 'Battery Pull Tab' to slide the battery out

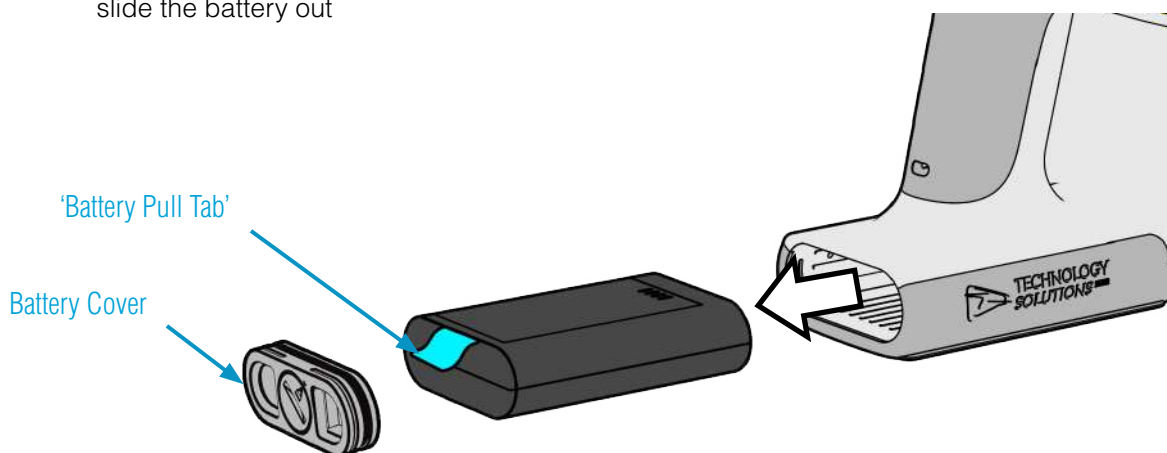
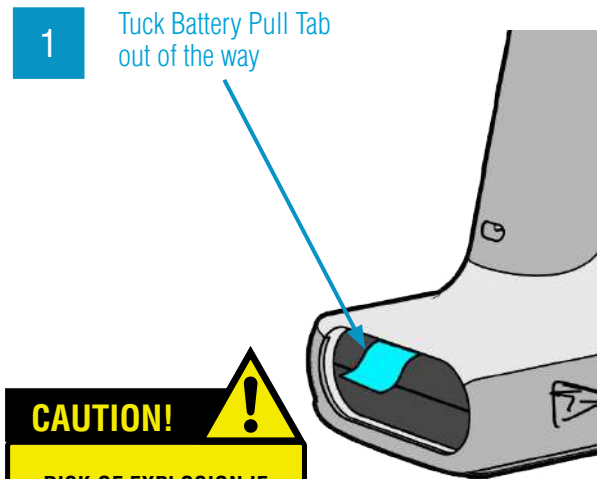

Figure 2: Battery Removal

INSTALLING THE BATTERY

To install the battery, first orientate the battery so that the electrical contacts on the battery line up with the contacts inside the 1166 battery cavity. Slide the battery into the battery cavity, then replace the Battery Cover. Make sure that the 'Battery Pull Tab' does not get stuck between the battery cover and the battery cavity - if this happens then the environmental sealing will be compromised.



CAUTION!

RISK OF EXPLOSION IF BATTERY IS REPLACED BY AN INCORRECT TYPE.

DISPOSE OF USED BATTERIES ACCORDING TO THE INSTRUCTIONS.

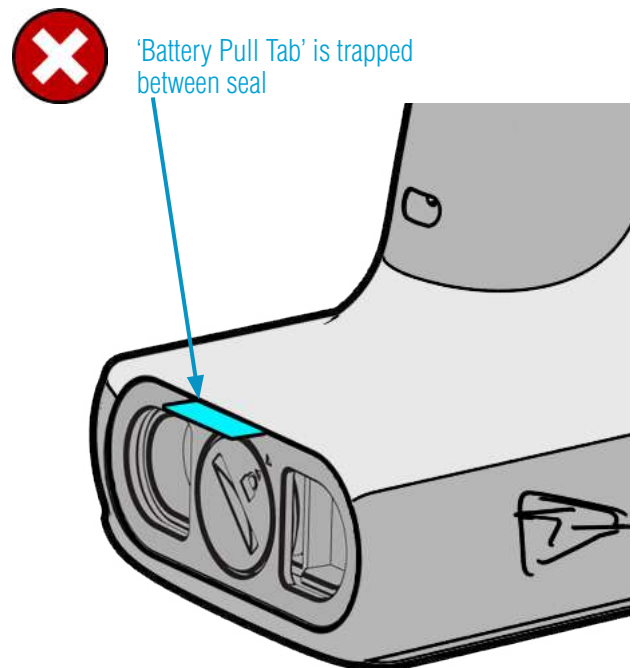
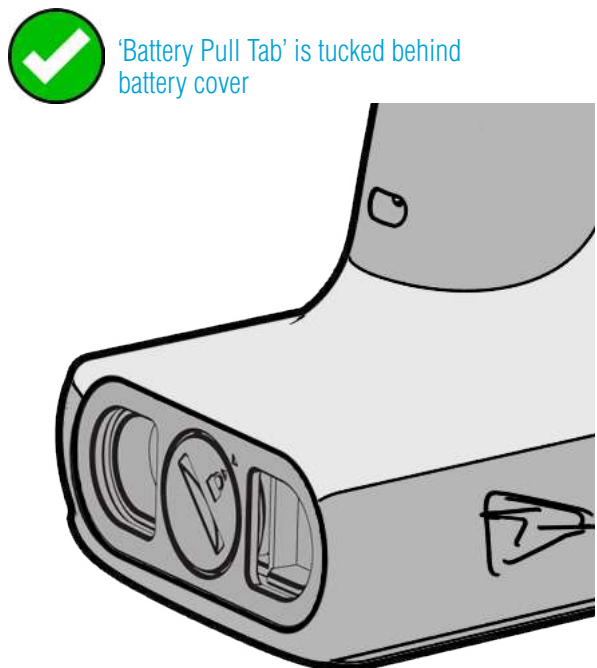
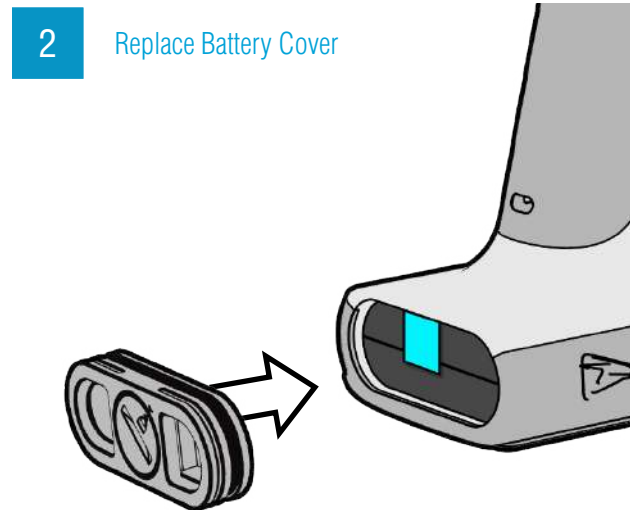
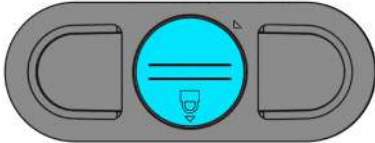

Figure 3: Battery Pull Tab - Correct and Incorrect positioning

LOCKING THE BATTERY COVER

To lock the battery cover, lightly tighten the 'Battery Cover Screw' in a clockwise direction using a mid-sized coin. Do not over-tighten the screw as this will damage the seal.

- 1 Locate 'Battery Cover Screw'



- 2 Lightly rotate the 'Battery Cover Screw' clockwise until the padlock symbol meets the arrow. Do not over-tighten or you will risk damaging the seal.

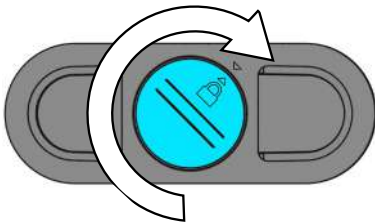

CHARGING AND USB CONNECTION

SETTING UP THE 1166 DOCKING STATION KIT

The 1166 UHF Reader kit uses a dedicated Docking Station for charging and synchronisation. The Docking Station Kit includes the dock, a power supply unit and a Mini USB cable. A separately purchased IEC mains cable is also required. The Mini USB cable and power cable are inserted into the 1166 Docking Station in the orientation shown below. Note that both cables plug into the back of the docking station at a slight upwards angle.

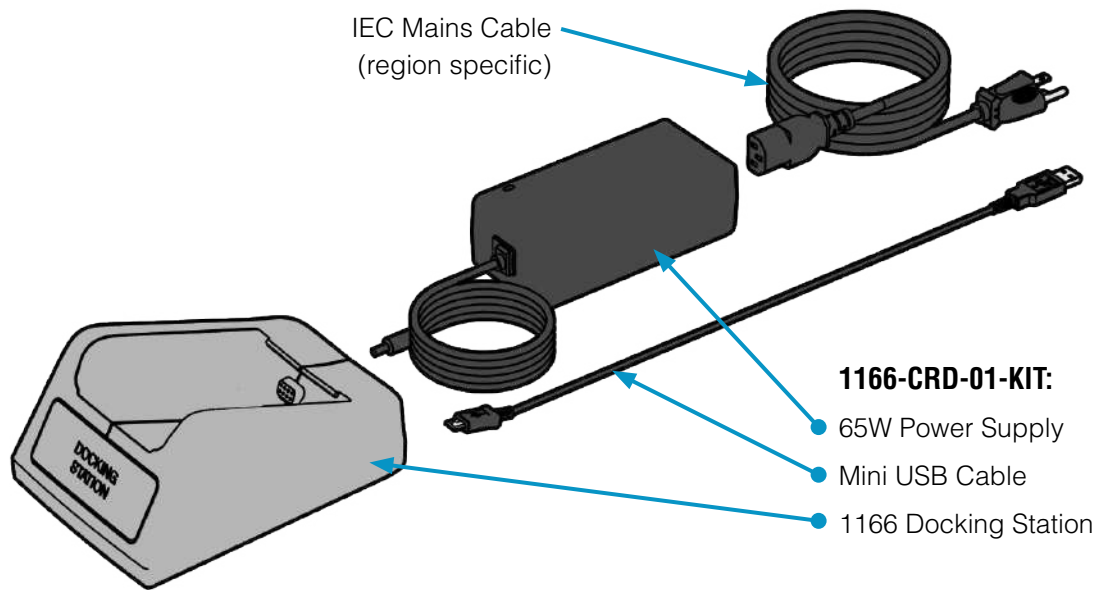

Figure 4: Components required for charging the 1166 UHF Reader

USING THE 1166 DOCKING STATION

To dock the 1166 UHF Reader, slide it into the docking station in the direction shown:

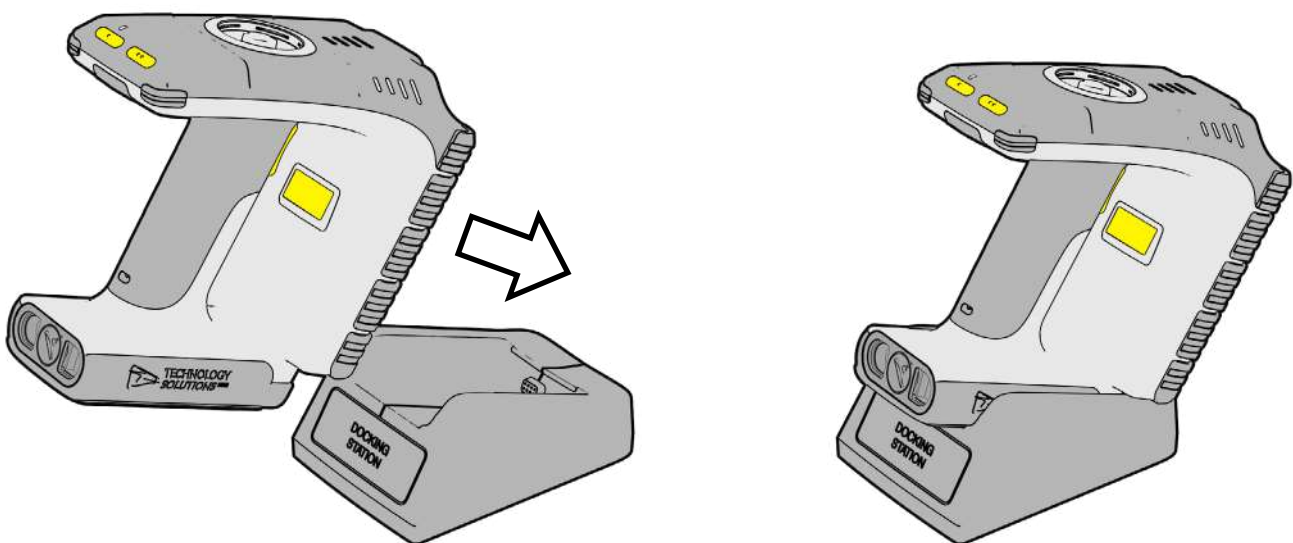
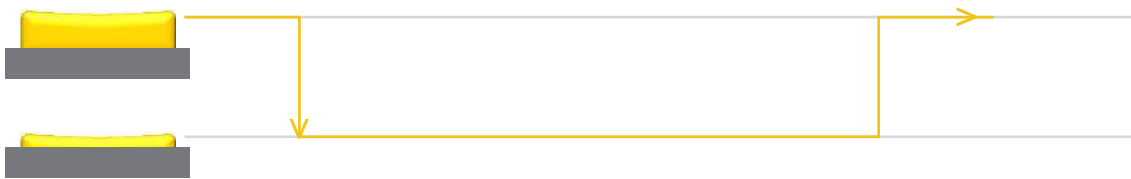

Figure 5: Inserting the 1166 UHF Reader into the 1166 Docking Station

BUTTON OPERATION

The 1166 UHF Reader has a Primary button action and a Secondary button action which can be initiated by different button clicks: By default, the Primary action scans for UHF transponders, whilst the Secondary action initiates the laser barcode scanner (Barcode scanning is only available with the 2D Imager Antenna variant). Which operation is performed depends on the way in which the button is pressed. The Single and Double press button options are also programmable.

PRIMARY BUTTON CLICK AND HOLD - UHF Transponder Read



The primary button click is a standard button action:

- To initiate a primary button click press and hold the trigger button.
- To terminate a primary button click release the trigger button.

In the default configuration the 1166 UHF Reader scans for UHF transponders as the primary function. The 1166 UHF Reader will continue to scan for UHF transponders while the button is pressed. It will stop scanning once the button is released (and the current operation completes).

SECONDARY BUTTON DOUBLE CLICK AND HOLD – Barcode Scan (2D Imager Variant only)

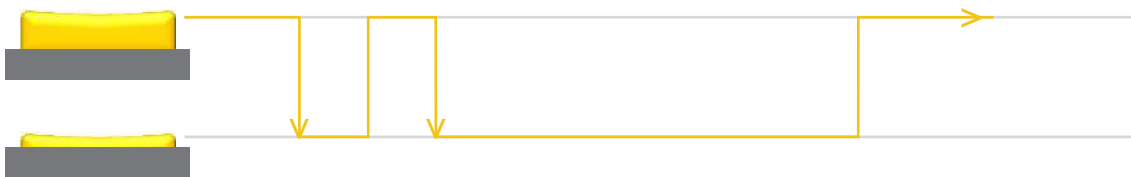

The secondary button click is a single click quickly followed by a second press (press-release-press).

- To initiate a secondary button click press then release then press and hold the trigger button.
- To terminate a secondary button click release the trigger button.

In the default configuration the 1166 UHF Reader scans for barcodes as the secondary function. The 1166 UHF Reader will continue to scan for a barcode while the button is pressed. It will stop scanning when any of the following conditions are met:

- A barcode is scanned.
- The button is released.
- The barcode engine times out.

READING TRANSPONDERS

RFID transponders can be read when they are in range of the antenna. The antenna is located on the front of the 1166 UHF Reader. The range at which a transponder can be read depends on the transponder type and size, and the number of transponders in the field.

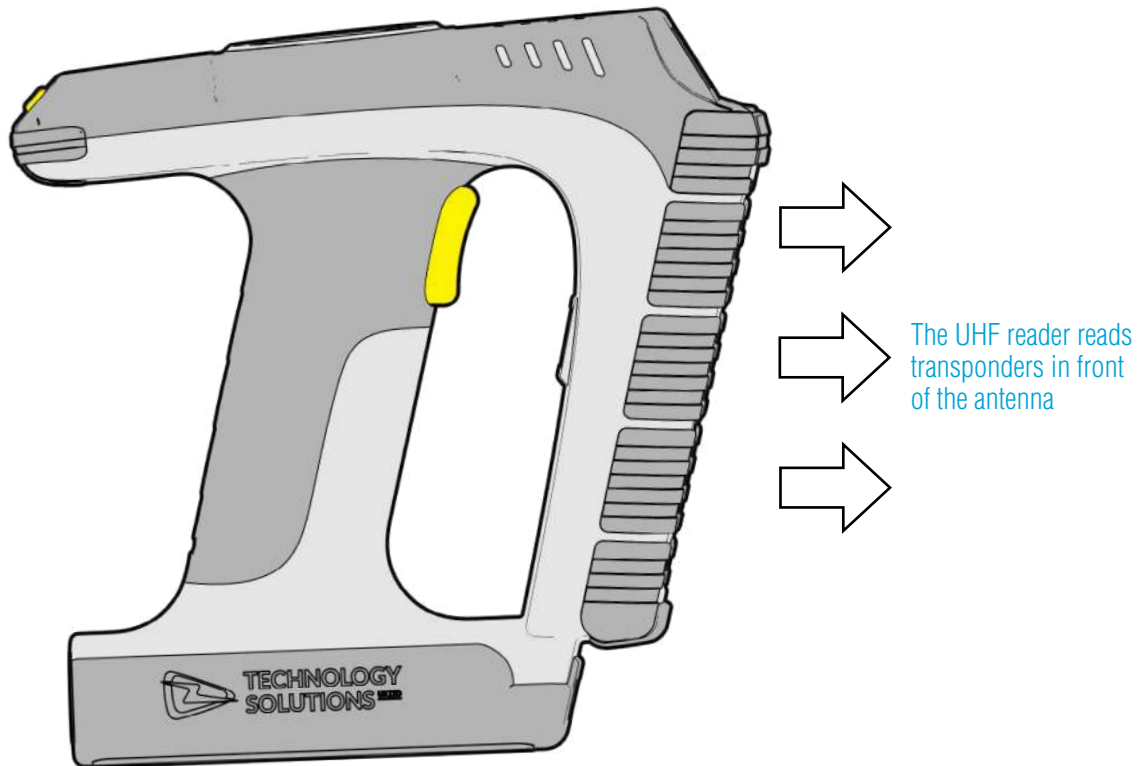

Figure 6: Antenna location and read direction

STATUS LEDS

LEDS INDICATING TAG/ BARCODE READ

 All off - nothing read

 Tag/barcode successfully read

LEDS INDICATING CHARGING STATUS

 All off - Not Charging

 Battery Charging, battery level less than 25%

 Battery Charging, battery level between 25 and 50%

 Battery Charging, battery level between 50 and 75%

 Battery Charging, battery level between 75 and 99%

 Battery Fully Charged

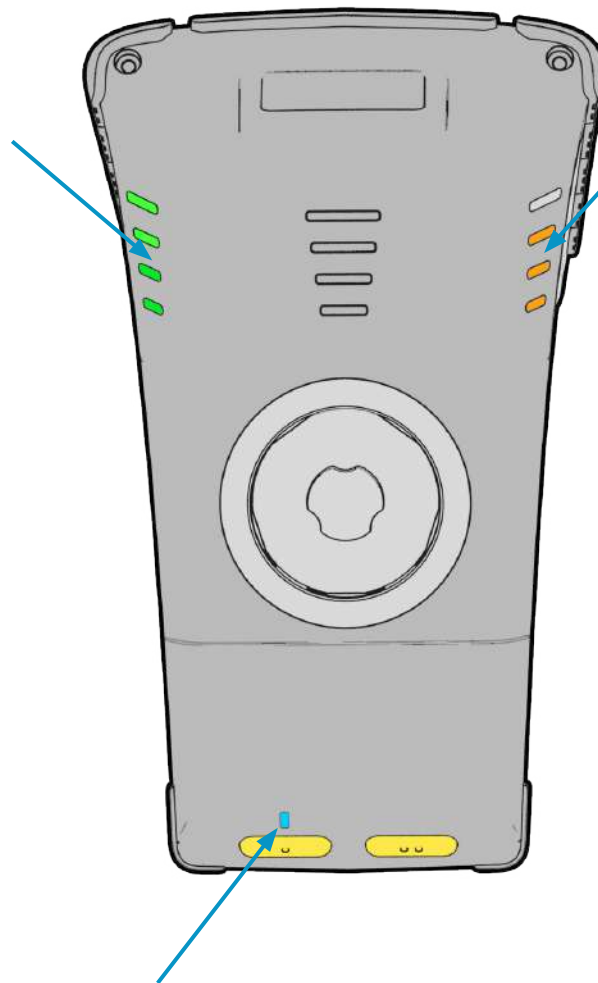

LED INDICATING CONNECTION STATUS

 Off - The reader is not awake

 Flashing - Reader is awake but there is no connection

 On - Reader is awake and connected to a host

Figure 7: Location of Status LEDs

CONNECTIONS

The connection to the 1166 is either via Bluetooth or USB. Bluetooth connections use either a Virtual Com Port (VCP) or via the iAP protocol for Apple devices. Over USB only VCP is available.

For VCP the connection is established at 115200 baud, 8 data bits, no parity, 1 stop bit and RTS/CTS (hardware) flow control.

BLUETOOTH® WIRELESS TECHNOLOGY CONNECTION

COMPATIBLE APPLE PRODUCT MODELS

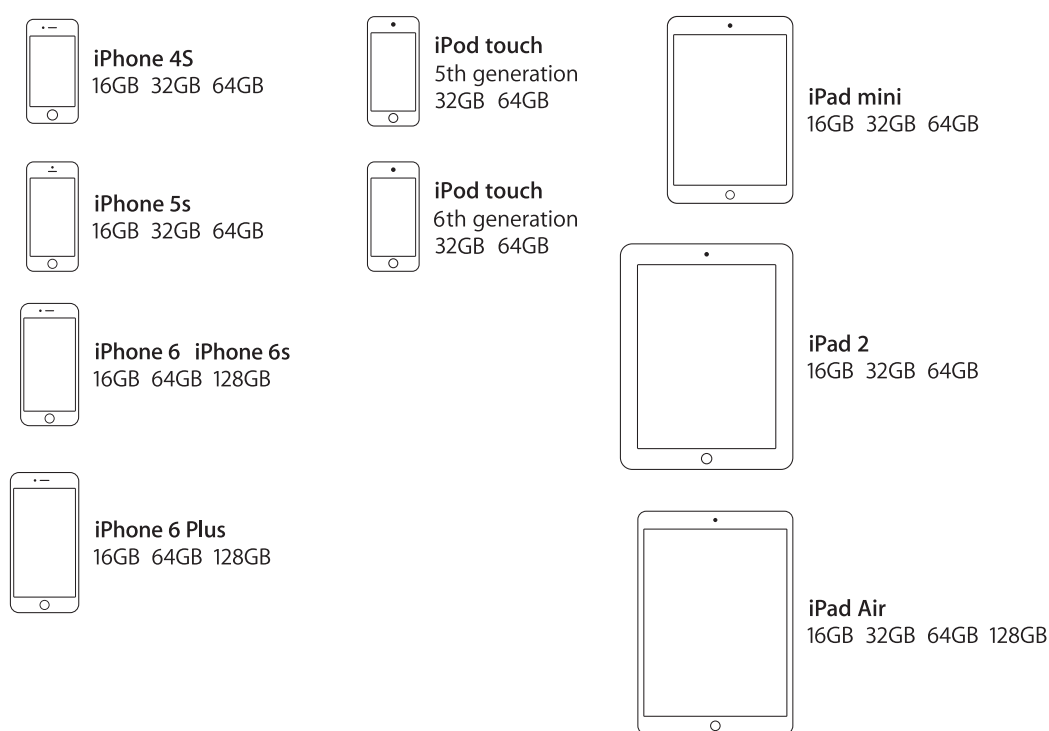

Figure 8: Compatible Apple Products

OTHER COMPATIBLE PRODUCTS

The 1166 Rugged *Bluetooth*® Handheld UHF RFID Reader is compatible with many other *Bluetooth*® wireless technology enabled host devices running Android, Windows CE, Windows Mobile 5/6.1/6.5 or Windows 10/8/7/Vista/XP.

COMPARISON OF *BLUETOOTH*[®] OPERATING MODES

Our UHF RFID *Bluetooth*[®] readers support two modes of operation over *Bluetooth*[®]. When connected via USB the reader always supports the TSL ASCII 2 protocol, but when connected over *Bluetooth*[®] the reader can either be set to use the TSL ASCII 2 protocol (*Bluetooth*[®] SPP Mode) or it can appear as a *Bluetooth*[®] keyboard (*Bluetooth*[®] HID Mode).

The comparison chart below is designed to help you understand the differences between the two operating modes:

<i>Bluetooth</i> [®] SPP Mode	<i>Bluetooth</i> [®] HID Mode
Apps need to be written with specific support for the Reader	Apps can use the Reader without modification
<p>The Reader can be discovered and paired in the Bluetooth Settings or from within the App but the App controls the connection</p> <ul style="list-style-type: none"> ● Connects when instructed by the App ● Disconnects when instructed by the App ● The reader powers off when no longer connected and idle ● The App needs to connect to restore 	<p>Reader is discovered and paired in the Host Bluetooth Settings (often appears as a Keyboard)</p> <ul style="list-style-type: none"> ● After pairing the reader connects automatically ● If idle the reader sleeps and the connection is dropped ● The reader, when woken, automatically reconnects to the host device
Apps receive and interpret TSL ASCII 2 Protocol responses when the user triggers a UHF or barcode scan	Apps receive input as Key strokes from the reader including Tab and Return/Enter keys
<p>The App can respond and react intelligently to responses e.g.</p> <ul style="list-style-type: none"> ● duplicate responses can be ignored or counted ● incoming tag data can be truncated, stripped or transformed into alternative representations: Hex, ASCII, GS1 EPC URI, etc... 	<p>The reader types text for each barcode/UHF scan received</p> <ul style="list-style-type: none"> ● The tag values can be returned in Hex or ASCII representations ● Up to 2 Additional characters can be inserted before and after the text sent ● The reader cannot truncate or strip values from tag data
The App can change the Reader's behaviour	The Reader can only send scanned data to the host, the host cannot change the reader's behaviour
The Reader's behaviour and command parameters are controlled in real time by the App e.g. the trigger action can change to suit the task that the User is performing; the App can allow the User to specify Inventory output power	The Reader's behaviour, such as the action of the reader's trigger switch, the inventory output power, the idle sleep timeout and other command parameters can be configured only once at start-up.
Configuration is held within the App (any configuration in the AUTO.TXT is likely to be overridden by the App settings)	All configuration is held in an AUTO.TXT file stored on an SD-Card. Removing the SD-card or deleting the AUTO.TXT and power-cycling the unit restores default settings.
All reader activity, by default, is saved to a log file if an SD-Card is fitted.	All reader activity, by default, is saved to a log file if an SD-card is fitted.

CHANGING THE *BLUETOOTH*[®] OPERATING MODE

TSL[®] *Bluetooth*[®] UHF RFID Readers can be operated in *SPP mode* where the Reader is controlled by a custom-written application or in *HID mode*, where the Reader behaves like a *Bluetooth*[®] Keyboard.

The HID mode has two variants¹ :

1. *HID mode* Compatible with Android, Windows and Apple devices
2. *HID Apple mode* Compatible only with Apple devices providing an on-screen keyboard toggle

The *Bluetooth*[®] operating mode of a TSL[®] UHF RFID Reader can be changed using the steps detailed below.

PREPARATION:

Download and install the "[TSL PC Firmware Downloader](#)" from the Reader product download page (free, one time, registration required)

<https://www.tsl.com/downloads/tsl-products/1128-downloads/>

<https://www.tsl.com/downloads/tsl-products/1153-downloads/>

<https://www.tsl.com/downloads/tsl-products/1166-downloads/>

TO SWITCH TO *BLUETOOTH*[®] HID MODE:

- First delete existing pairings to the UHF reader
- Launch the Firmware Downloader (*Desktop Firmware Loader*)
- Connect the UHF reader to the computer using the supplied USB cable.
- The driver should install automatically (*)
- The downloader should prompt as the com port arrives and select the com port automatically ("COMn arrived")
- Select **Action>Reset Bluetooth to HID mode** or **Action>Reset Bluetooth to HID Apple mode** (wait for the process to complete)
- Disconnect the UHF reader from the computer (unplug USB)
- Wake the UHF reader (pull trigger, blue flashing LED)
- Pair to the reader on the device (it typically appears as a keyboard icon and connects automatically)
- Scanned data should now be typed into the current application on the device

TO SWITCH TO *BLUETOOTH*[®] SPP MODE:

- First delete existing pairings to the UHF reader
- Launch the downloader (*Desktop Firmware Loader*)
- Connect the UHF reader to the computer using the supplied USB cable.
- The driver should install automatically (*)
- The downloader should prompt as the com port arrives and select the com port automatically ("COMn

- arrived”)
- Select **Action>Reset Bluetooth to SPP mode** (wait for the process to complete)
- Disconnect the UHF reader from the computer (unplug USB)
- Wake the UHF reader (pull trigger, blue flashing LED)
- Pair to the reader on the device
- Launch an Application (e.g. *RFID Explorer*) to use the reader

(*) if not download from here <http://www.ftdichip.com/Drivers/VCP.htm>

FURTHER INFORMATION

Further information can be found from the Reader Download pages (free, one-time, registration required - see links above)

Application Note – Bluetooth® HID mode: Provides further examples for configuring HID mode

Application Note – Using the Micro SD log and auto-run files: Describes using the AUTO.TXT

TSL ASCII Protocol 2.4 Rev B: Details all the commands including for HID `.st`, `.hs`, `.hc`, and `.hd`

If you encounter any issue while following the above procedure please contact support@tsl.com providing the following information:

- The serial number of the UHF Reader
- The Firmware version of the UHF Reader
- The step at which the procedure failed
- A description of the fault that occurred

Firmware requirements: 1128 - v4.2.7 or greater; 1153 – v2.1.7 or greater; 1166 – v1.1.6 or greater

SETTING UP A *BLUETOOTH*® CONNECTION WITH AN APPLE PRODUCT

Awaken the 1166 UHF Reader by squeezing the trigger, which is confirmed by the flashing of the blue LED. To pair with your iOS device, navigate to the *Bluetooth*® option within the Settings menu on your iOS device.

VIEW LIST OF *BLUETOOTH*® DEVICES (iOS 7)

iPad® :



Figure 9: List of devices in *Bluetooth*® settings

- Go to the Settings App.
- Select the *Bluetooth*® settings in the left hand column.

iPod® / iPhone® :



Figure 10: Select *Bluetooth*® settings

- Go to the Settings App.



Figure 11: List of devices in *Bluetooth*® settings

- Tap on the *Bluetooth*® row to be taken to the *Bluetooth*® settings

PAIR WITH TSL *BLUETOOTH*® DEVICE

In the list of *Bluetooth*® devices, the 1166 UHF reader will be identified by its serial number (1166-xxxxxx). Click on the corresponding row to pair with the reader.



iPad®

iPod® / iPhone®

Figure 12: Identify device

After successfully pairing with the 1166 UHF Reader, the device will be shown as 'connected'.



iPad®

iPod® / iPhone®

Figure 13: Device connected

If RFID Explorer is installed on your device then a prompt will appear requesting a connection to the newly added reader. Choose 'Allow' to launch RFID Explorer or 'Ignore' if the device is to be used with a different App.

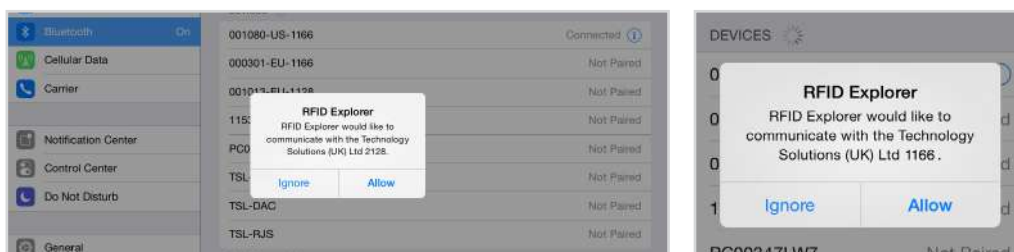

iPad®

iPod® / iPhone®

Figure 14: Allow connection



Open TSL's RFID Explorer App.

The RFID Explorer App can be downloaded from the App Store.

If the app is starting up for the first time, no reader will be selected. To select a reader, tap on 'Change Reader' in the menu to the left (iPad®) or 'Paired Readers' (iPod®/iPhone®).

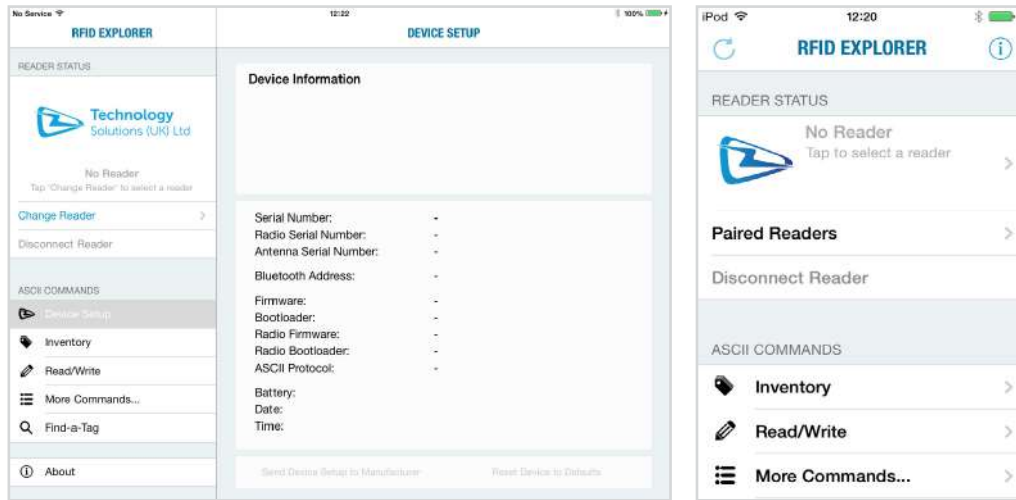

iPad®

iPod® / iPhone®

Figure 15: TSL RFID Explorer App on first load - no reader selected

If you have a reader selected from your device's Bluetooth® settings as previously shown, continue from Figure 28. If the 'No devices are available' message in Figure 25 appears, you can also connect to a device through the RFID Explorer app. Press the + sign presented in the top right corner of the Select Reader section/screen.

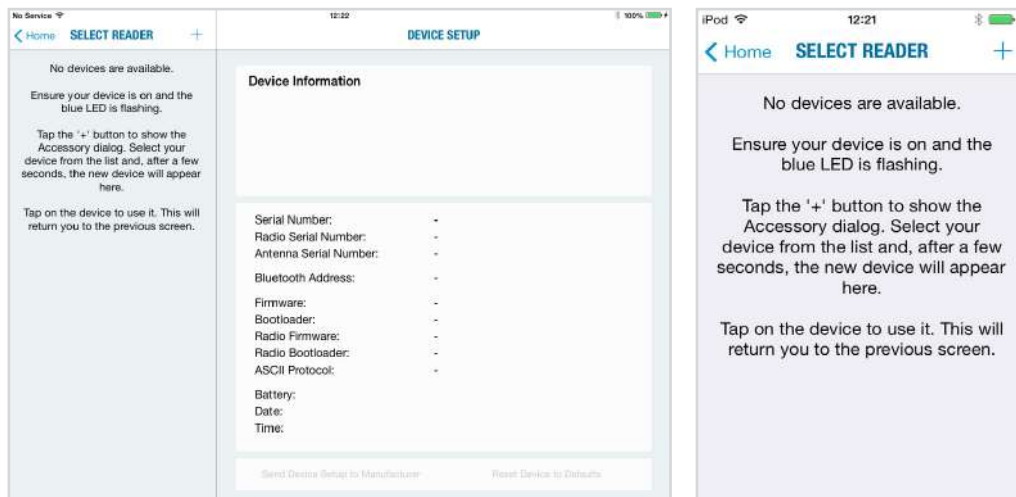

iPad®

iPod® / iPhone®

Figure 16: No devices are available

This will open a 'Select An Accessory' dialog box.
There may be a small delay in loading available readers.

Once the available readers have loaded select the 1166 UHF reader.

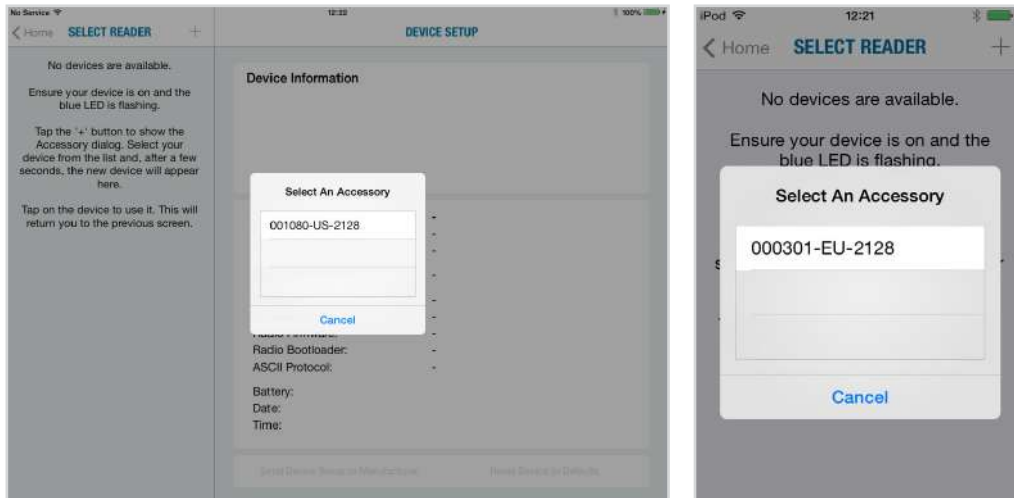

iPad®

iPod® / iPhone®

Figure 17: Select the Reader to use

A list of compatible and currently paired *Bluetooth*® devices will appear. Select the device to be used with the RFID Explorer App.

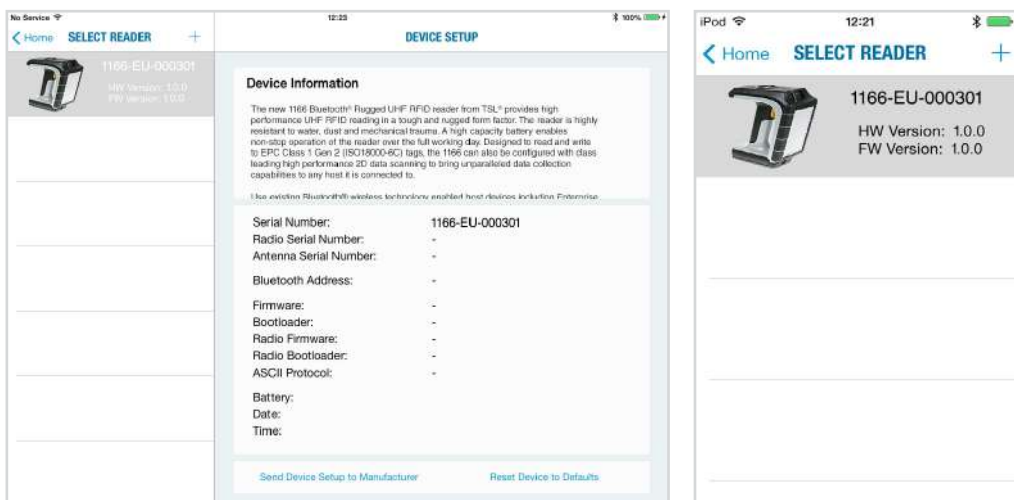

iPad®

iPod® / iPhone®

Figure 18: List of paired *Bluetooth*® devices

The selected device's image will appear, accompanied by relevant device information. The 'Inventory', 'Read/Write', 'Commands' and 'Find a Tag' features can now be explored. To maximise battery life it is recommended to release the 1166 UHF Reader from its *Bluetooth®* connection if the reader is not to be used for a significant period of time.

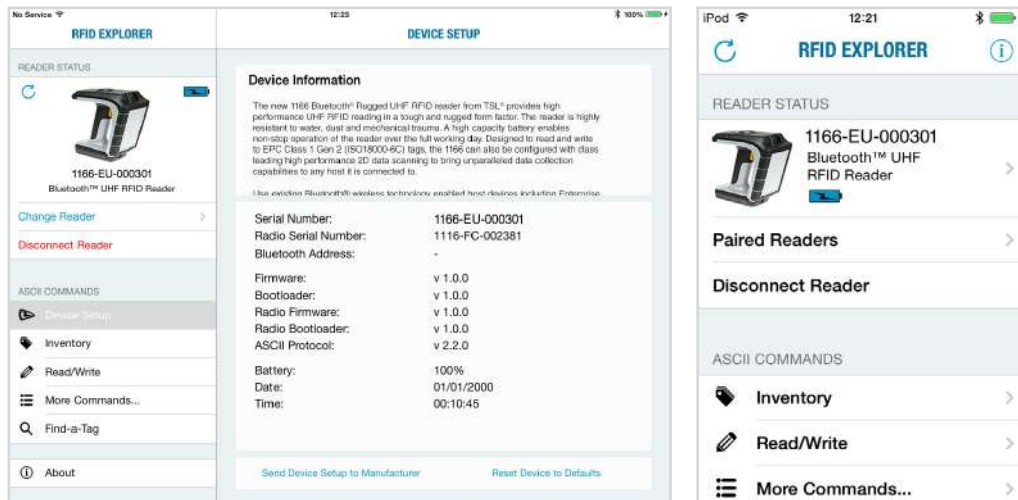

iPad®

iPod® / iPhone®

Figure 19: 1166 UHF Reader selected and ready to use

EMBEDDED SD CARD

SUMMARY

The 1166 Rugged Bluetooth® UHF RFID Reader is factory fitted with an embedded 2GB internal NAND storage SD card, allowing millions of tags to be stored with time and date stamping.

By default the SD card is presented as a mass storage device when the 1166 is docked into a cradle connected over USB to a host computer. This allows rapid download of log data and editing of the Auto Run File. The standard ASCII 2 SD card commands can still be used, but only when the SD card is not in mass storage mode.

AUTO RUN FILE (AUTO.TXT)

Once an SD card is installed an Auto Run file can be created on the SD card. The Auto Run file contains a list of ASCII 2 commands that are executed as the 1166 powers up. The file should be located at the root of the card and called "AUTO.TXT". Although the file can contain any valid ASCII 2 commands, one per line, it is intended that these have the take no action '-n' flag specified to allow the default parameters for any command to be changed from the firmware defaults as the unit boots without actually executing the command.

For example to change the carrier power of the inventory command from 29dBm to 20dBm

'iv -o20 -n' would be appended to the Auto Run file. As is the behaviour with command parameters this will set the output power for the inventory command until a new value is sent with this command. Therefore the inventories executed by the trigger, which executes 'iv' will use the modified output power.

The Auto Run file can be manually created on the card before it is inserted into the 1166 or the ASCII 2 command Write Command to Auto Run File '.wa' can be used. The Read Auto Run File '.ra' can be used to read back the contents of the Auto Run file or delete the file from the card.

LOG FILE (LOG.TXT)

Once an SD card is installed and logging is enabled a log file is created on the SD card. The file is located at the root of the card and called "LOG.TXT". All the lines from every response to every command that is executed by the reader (including those performed from trigger actions) are appended to the end of the file. Events such as Power up are also appended to the file.

The ASCII 2 Read Log File command ('.rl') is provided to enable or disable logging, to read the log file from the card or to delete the log file from the card.

Please note that the log file can quickly become large relative to the speed at which it can be downloaded using the Read Log File Command.

Start of a sample log output:

```
DT: 2013-11-15T16:46:58
EV: Log File created
CS: .ws -sa4 -sbepc -sd300833B2DDD9014000000000 -s106 -so0002 -sts2 -dbepc -da330DE29525C0210005F5F88A
-dl106 -do0002
WW: 0
ME: No Transponder found
ER:005
DT: 2013-11-15T17:58:28
EV: Disconnected
DT: 2013-11-15T17:59:28
EV: Sleep
DT: 2013-11-18T09:18:21
```

```
EV: Wake up
CS: .al -dlon
OK:
DT: 2013-11-18T09:19:22
EV: Sleep
DT: 2013-11-18T10:07:42
EV: Wake up
DT: 2013-11-18T10:07:42
EV: Connected USB
CS: .al -dlon
OK:
CS: .iv LCMD 000000 -qss0 -qta
EP: 330DE29525C0210005F5F8F2
EP: 22100150000000000000000027
OK:
```

SOFTWARE DEVELOPMENT

To make full use of the functionality of the 1166 UHF Reader, a customised software application will be required.

The new 1166 *Bluetooth*[®] UHF RFID reader incorporates TSL's unique ASCII protocol for faster and easier application development. This sophisticated parameterised ASCII protocol provides the developer a powerful set of commands that carry out multiple actions locally within the *Bluetooth*[®] reader. This approach enables multiple tag operations executed using simple pre-configured ASCII commands which not only speeds integration of the reader into applications but also abstracts the developer from some of the complexities of the underlying Native API. Simple, text based commands are sent to the reader and responses are returned as text. This allows straightforward access to RFID tag functions such as inventory, read and write. Details of the ASCII command mode are available for download from <https://www.tsl.com/1166-downloads/>.

TROUBLESHOOTING AND MAINTENANCE

MAINTENANCE

For trouble-free service please observe the following tips when using the 1166 UHF Reader:

- Protect the 1166 UHF Reader from temperature extremes. Do not leave it on the dashboard of a car on a hot day, and keep it away from heat sources.

TROUBLESHOOTING

Symptoms	Possible cause	Action
Nothing happens when the trigger button is pressed.	If the LEDs are not on then the battery may be flat.	Charge the 1166 UHF Reader.
	The 1166 UHF Reader may have button actions disabled.	Check the 1166 UHF Reader configuration and restore to defaults if unsure.
	Other.	Work through Troubleshooting Guide on TSL® Website
The orange LED flashes rapidly when charging.	There is a battery fault.	Replace the battery pack.
	The battery pack temperature is outside recommended limits.	Ensure that charging only occurs between 5°C and 40°C.
The host <i>Bluetooth</i> ® discovery does not find the 1166 UHF Reader.	The 1166 UHF Reader has powered off.	Press the trigger button and ensure the blue LED is flashing.
	The 1166 UHF Reader is out of range.	Move the 1166 UHF Reader closer to the host.
	The <i>Bluetooth</i> ® friendly name of the 1166 UHF Reader has been changed.	Check the <i>Bluetooth</i> ® friendly name or restore the 1166 UHF Reader to factory defaults if unsure.
Opening the <i>Bluetooth</i> ® virtual com port does not connect to the 1166 UHF Reader.	The host has paired to a different <i>Bluetooth</i> ® device.	Pair to the required 1166 UHF Reader.
	The host <i>Bluetooth</i> ® function has an error.	Warm boot the host. If this does not help, delete the 1166 UHF Reader from the favourites list and re-pair.
<i>Bluetooth</i> ® pairing fails.	The PIN on the 1166 UHF Reader has been changed	Set the <i>Bluetooth</i> ® PIN to a known value
Other symptoms.	Other fault.	Run ASCII Remote Diagnostic and email result to support@tsl.com along with a description of the problem.

REGULATORY INFORMATION

INFORMATION TO THE USER – FCC

FCC warning statement:

This device complies with Part 15 of the FCC Rules.

Operation is subject to the following two conditions:

- (1) This device may not cause harmful interference, and
- (2) This device must accept any interference received, including interference that may cause undesired operation.

To comply with FCC RF exposure compliance requirements this unit must be operated in the hand with a minimum separation of 20cm from the body and other persons. Other operating configurations should be avoided. This unit must not be co-located or operated in conjunction with any other transmitter / antenna except those already approved in this filing. Handheld configurations that provide no belt-clips or other body-worn accessories and only transmit while in the hand and that maintain 20cm from the body, excluding hands, wrists, feet and ankles, are allowed.

Changes or modifications not expressly approved by the party responsible for compliance could void the user's authority to operate the equipment

RF EXPOSURE GUIDELINES

Safety information – To reduce RF exposure only use the device in accordance with the instructions supplied.

CANADIAN WARNING STATEMENTS

English

“Under Industry Canada regulations, this radio transmitter may only operate using an antenna of a type and maximum (or lesser) gain approved for the transmitter by Industry Canada.

To reduce potential radio interference to other users, the antenna type and its gain should be so chosen that the equivalent isotropically radiated power (e.i.r.p.) is not more than that necessary for successful communication.”

“This device complies with Industry Canada licence-exempt RSS standard(s). Operation is subject to the following two conditions: (1) this device may not cause interference, and (2) this device must accept any interference, including interference that may cause undesired operation of the device.”

French

“Conformément à la réglementation d'Industrie Canada, le présent émetteur radio peut fonctionner avec une antenne d'un type et d'un gain maximal (ou inférieur) approuvé pour l'émetteur par Industrie Canada.

Dans le but de réduire les risques de brouillage radioélectrique à l'intention des autres utilisateurs, il faut choisir le type d'antenne et son gain de sorte que la puissance isotrope rayonnée équivalente (p.i.r.e.) ne dépasse pas l'intensité nécessaire à l'établissement d'une communication satisfaisante.”

“Le présent appareil est conforme aux CNR d’Industrie Canada applicables aux appareils radio exempts de licence. L’exploitation est autorisée aux deux conditions suivantes : (1) l’appareil ne doit pas produire de brouillage, et (2) l’utilisateur de l’appareil doit accepter tout brouillage radioélectrique subi, même si le brouillage est susceptible d’en compromettre le fonctionnement.”

LASER WARNING



A warning label is also shown on the back of the antenna when a barcode reader is fitted.

The barcode reader module complies with 21 CFR 1040.10 and 1040.11 except for deviations pursuant to Laser Notice No. 50, dated June 24, 2007, EN60825-1:2007 and IEC60825-1:2001 (Ed.1.2)

Avoid unnecessary exposure to the laser light.

Caution: Use of controls, adjustments or performance of procedures other than those specified herein may result in hazardous laser light exposure.

Caution: Viewing the illumination from the barcode reader with optical instruments may result in increased hazard.

HEALTH AND SAFETY RECOMMENDATIONS

Ergonomic Recommendations

Caution: In order to avoid or minimize the potential risk of ergonomic injury, follow the recommendations below. Consult with your local Health & Safety Manager to ensure that you are adhering to your company's safety programs to prevent employee injury.

- Reduce or eliminate repetitive motion
- Maintain a natural position
- Reduce or eliminate excessive force
- Keep objects that are used frequently within easy reach Perform tasks at correct heights
- Reduce or eliminate vibration
- Reduce or eliminate direct pressure
- Provide adjustable workstations
- Provide adequate clearance
- Provide a suitable working environment
- Improve work procedures.

For vehicle installation and use

An air bag inflates with great force. DO NOT place objects, including either installed or portable wireless equipment, in the area over the air bag or in the air bag deployment area. If in-vehicle wireless equipment is improperly installed and the air bag inflates, serious injury could result.

RF signals may affect improperly installed or inadequately shielded electronic systems in motor vehicles (including safety systems). Check with the manufacturer or its representative regarding your vehicle. You should also consult the manufacturer of any equipment that has been added to your vehicle.

Power Supply

Use only TSL®-approved cradles, chargers and power supplies with the 1166 UHF Reader. Use of an alternative power supply will invalidate any approval given to this device, void the warranty for the product and may be dangerous.

WASTE ELECTRICAL AND ELECTRONIC EQUIPMENT (WEEE)

For EU Customers: All products at the end of their life must be returned to TSL® for recycling. For information on how to return product please contact TSL®.

WARRANTY

(A) Warranty

TSL's hardware Products are warranted against defects in workmanship and materials for a period of twelve (12) months from the date of shipment, unless otherwise provided by TSL® in writing, provided the Product remains unmodified and is operated under normal and proper conditions. Warranty provisions and durations on software, integrated installed systems, Product modified or designed to meet specific customer specifications ("Custom Products"), remanufactured products, and reconditioned or upgraded products, shall be as provided in the applicable Product specification in effect at the time of purchase or in the accompanying software license.

(B) Spare Parts

Spare parts (i.e. parts, components, or subassemblies sold by TSL® for use in the service and maintenance of Products) are warranted against defects in workmanship and materials for a period of thirty (30) days from the date of shipment. Spare parts may be new or originate from returned units under the conditions set forth in subsection D below.

(C) Repair of TSL® branded hardware

For repairs on TSL® branded hardware Products under this Agreement, including repairs covered by warranty, the repair services provided are warranted against defects in workmanship and materials on the repaired component of the Product for a period of thirty (30) days from the shipment date of the repaired Product, or until the end of the original warranty period, whichever is longer. Any such defects shall be notified to TSL® in writing within 7 days of the same becoming apparent.

(D) Product Service

Products may be serviced or manufactured with parts, components, or subassemblies that originate from returned products and that have been tested as meeting applicable specifications for equivalent new material and Products. The sole obligation of TSL® for defective hardware Products is limited to repair or replacement (at TSL's option) on a "return to base (RTB)" basis with prior TSL® authorisation.

Customer is responsible for prompt shipment to TSL® and assumes all costs and risks associated with this transportation; return shipment to the Customer will be at TSL's expense. Customer shall be responsible for return shipment charges for product returned where TSL® determines there is no defect ("No Defect Found"), or for product returned that TSL® determines is not eligible for warranty repair. No charge will be made to Buyer for replacement parts for warranty repairs. TSL® is not responsible for any damage to or loss of any software programs, data or removable data storage media, or the restoration or reinstallation of any software programs or data other than the software, if any, installed by TSL® during manufacture of the Product.

(E) Original Warranty Period

Except for the warranty applying solely to the repaired component arising from a repair service as provided in Section C above, the aforementioned provisions do not extend the original warranty period of any Product that had either been repaired or replaced by TSL®.

(F) Warranty Provisions

The above warranty provisions shall not apply to any Product:

- (i) which has been repaired, tampered with, altered or modified, except by TSL®'s authorized service personnel;
- (ii) in which the defects or damage to the Product result from normal wear and tear, misuse, negligence, improper storage, water or other liquids, battery leakage, use of parts or accessories not approved or supplied by TSL®, or failure to perform operator handling and scheduled maintenance instructions supplied by TSL®;
- (iii) which has been subjected to unusual physical or electrical stress, abuse, or accident, or forces or exposure beyond normal use within the specified operational and environmental parameters set forth in the applicable Product specification; nor shall the above warranty provisions apply to any expendable or consumable items, such as batteries, supplied with the Product.

EXCEPT FOR THE WARRANTY OF TITLE AND THE EXPRESS WARRANTIES STATED ABOVE, TSL® DISCLAIMS ALL WARRANTIES ON PRODUCTS FURNISHED HEREUNDER INCLUDING ALL IMPLIED WARRANTIES OF MERCHANTABILITY AND FITNESS FOR A PARTICULAR USE. ANY IMPLIED WARRANTIES THAT MAY BE IMPOSED BY LAW ARE LIMITED IN DURATION TO THE LIMITED WARRANTY PERIOD. SOME STATES OR COUNTRIES DO NOT ALLOW A LIMITATION ON HOW LONG AN IMPLIED WARRANTY LASTS OR THE EXCLUSION OR LIMITATION OF INCIDENTAL OR CONSEQUENTIAL DAMAGES OR CONSUMER PRODUCTS. IN SUCH STATES OR COUNTRIES, FOR SUCH PRODUCTS, SOME EXCLUSIONS OR LIMITATIONS OF THIS LIMITED WARRANTY MAY NOT APPLY.

The stated express warranties are in lieu of all obligations or liabilities on the part of TSL® for damages, including but not limited to, special, indirect or consequential damages arising out of or in connection with the use or performance of the Product or service. TSL's liability for damages to Buyer or others resulting from the use of any Product or service furnished hereunder shall in no way exceed the purchase price of said Product or the fair market value of said service, except in instances of injury to persons or property.

TSL® is not responsible for any damages incurred during shipment if the approved shipping container is not used. Shipping the units improperly can possibly void the warranty. If the original shipping container was not kept, contact your local distributor or TSL® to have another sent to you.

TSL® shall not be responsible for any injury, damage or loss of whatever kind caused directly or indirectly by the goods whether as a result of their manufacture, operation, use or otherwise and the customer shall indemnify TSL® from any claim arising from any loss suffered by any third party.

ABOUT TSL®

ABOUT

TSL® | Global Leaders in Mobile RFID

Technology Solutions UK Ltd (TSL®) is a leading manufacturer of high performance mobile RFID readers used to identify and track products, assets, data or personnel.

For over two decades, TSL® has delivered innovative data capture solutions to Fortune 500 companies around the world using a global network of distributors and system integrators. Specialist in-house teams design all aspects of the finished products and software ecosystems, including electronics, firmware, application development tools, RF design and injection mould tooling.

TSL® is an ISO 9001:2015 certified company.



ISO 9001: 2015

CONTACT

Address:	Technology Solutions (UK) Ltd, Suite A, Loughborough Technology Centre, Epinal Way, Loughborough, Leicestershire, LE11 3GE, United Kingdom.
Telephone:	+44 1509 238248
Fax:	+44 1509 214144
Email:	enquiries@tsl.com
Website:	www.tsl.com



Copyright © 2019 Technology Solutions (UK) Ltd. All rights reserved. Technology Solutions (UK) Limited reserves the right to change its products, specifications and services at any time without notice.